

Description

Metal Oxide Varistor (MOV) as one nonlinear resistance element is mainly made of zinc oxide (ZnO), which has very high surge capacity and big nonlinear coefficient. Below the threshold voltage, its resistance is very high, nearly no current flows through, but above the threshold voltage, the resistance reduces sharply, huge current can be discharged. Due to this characteristic, varistor as a protection component in electronic and electrical equipment can absorb abnormal over-voltage and lightning surge.

SETsafe | SETfuse varistor is with High Surge Current Density, Low Clamping Voltage, and Good Surge Capacity. It can also be customized as required.

Features

- Epoxy Resin Coating
- Silicone Resin Coating
- Low Leakage Current
- Bidirectional and Symmetrical V/I Characteristics
- RoHS & REACH Compliant
- Operating Temperature Range
Low Temperature: -40 °C
High Temperature: +85 °C / +105 °C

Lead Types

Lead Types		Codes
	Straight Lead	A
	Straight Strap Lead	E

Applications

- Power Supplies
- Home Electrical Appliances
- Industrial Devices
- Surge Protectors
- Telecom Devices

Product Structure

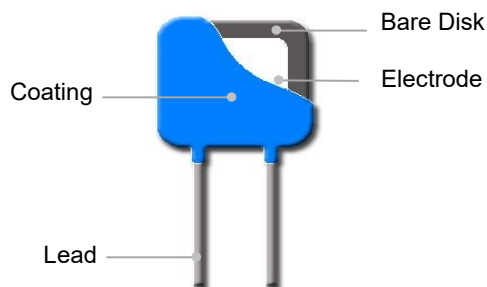

Agency	Standards	No.
	UL 1449 4 th Edition	E322662
	CSA C22.2 NO.269.5-17	E322662
	EN 61051-1:2008 IEC 61051-1:2007 IEC 61051-2:1991+A1 IEC 61051-2-2:1991 Annex Q of IEC 60950-1:2005+A1+A2	J 50401611

Marking

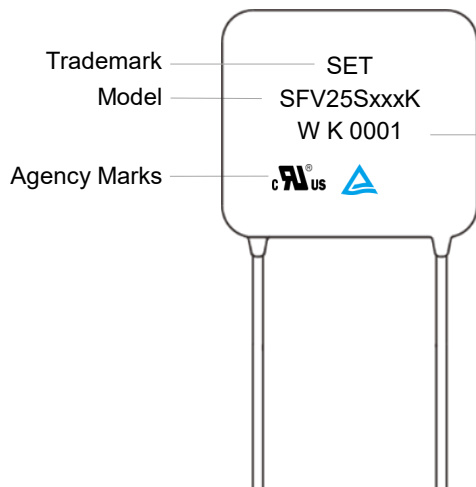

Internal code	
Year Code	2000—A 2022—W
Surge Level	K: Standard Type
Serial No.	(E.G.: 0001)

MOV

MOV

Temp. Derating Curve

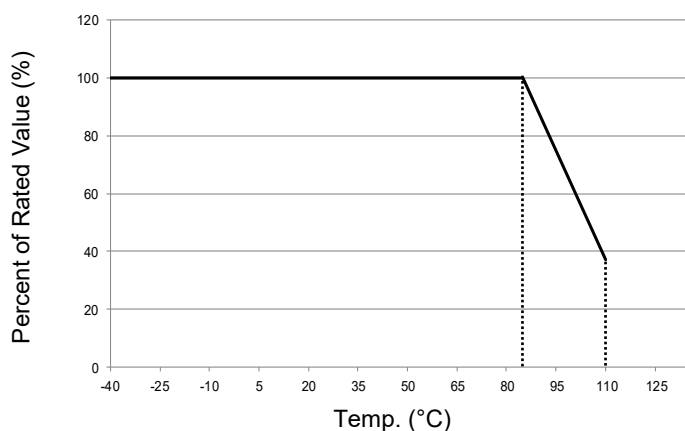

Note:
When ambient Temp. exceeds 85 °C, the peak surge current and energy rating should be reduced as shown in the left curve.

For Normal Temp. Series

General Technical Data

Item	Value	Unit
Operating Temperature	-40 to +85	°C
Storage Temperature	-40 to +125	°C
Voltage Proof	≥2500	V _{ac}
Insulation Resistance	≥100	MΩ

Part Numbering System

SFV 25 S 471 - K N K A BUL - 001

MOV

MOV

Other Options

***Packaging & Lead Length**

BUL: Bulk + Standard Lead Length
C35: Bulk + Cut to 3.5 mm
(Range:2.5 mm to 6 mm)

Lead Types

A: Straight Lead
E: Straight Strap Lead

Surge Level

K: Standard Type

Operating Temp.

N: Epoxy Coating 85 °C

Voltage Tolerance

K: ±10%
J: ±5%
S: Special Tolerance

Nominal Varistor Voltage

220: $22 \times 10^0 = 22 \text{ V}$
471: $47 \times 10^1 = 470 \text{ V}$
122: $12 \times 10^2 = 1200 \text{ V}$

Disk Shape

S: Square

Bare Disk Dimension

25: 25×25 mm

Product Category

SETfuse Varistor

*For more details refer to packaging information.

Glossary

Item	Description
V_N	Nominal Varistor Voltage Voltage, at specified D.C. current used as a reference point in the component characteristics.
I_L	Leakage Current Measuring at 75% of varistor voltage.
UCT	Upper Category Temp. Max. ambient temp. for which a varistor has been designed to operate continuously.
LCT	Lower Category Temp. Minimum ambient temp. at which a varistor has been designed to operate continuously.
Max. Peak Current	Max. Peak Current Max. current per pulse, which may be passed by a varistor at an ambient temp. of 25 °C, for a given number of pulses.
V_C	Clamping Voltage Peak voltage developed across the varistor terminations under standard atmospheric conditions, when passing an 8/20 μ s class current pulse.
Voltage Proof	Voltage Proof Max. peak voltage, which may be applied under continuous operating conditions between the varistor terminations and any conducting mounting surface (Applicable only to insulated varistors).
C_V	Capacitance Capacitance across the MOV measured at a specified frequency and voltage.
V_{ac}	Max. Continuous a.c. Voltage Max. a.c. r.m.s. voltage of a substantially sinusoidal waveform (less than 5% total harmonic distortion) which can be applied to the component under continuous operating conditions at 25 °C.
V_{dc}	Max. Continuous d.c. Voltage Max. d.c. voltage (with less than 5% ripple) which can be applied to the component under continuous operating conditions at an ambient temp. of 25 °C.

Dimensions (mm)

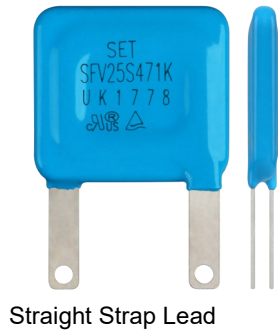

Straight Strap Lead

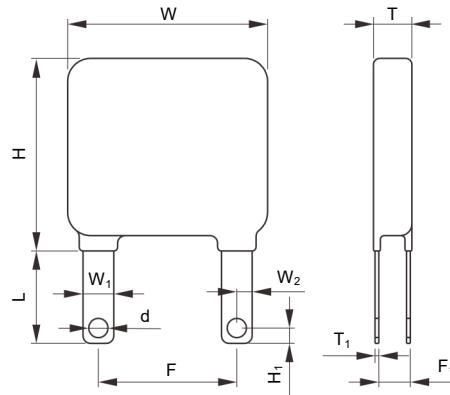

Model	L	W (Max.)	W ₁	W ₂	H (Max.)	H ₁	T (Max.)	T ₁	d	F	F ₁
SFV25S220K	12.0±3.0	28	4.00±0.05	2.00±0.05	30	2.00±0.05	4.2	0.50±0.05	2.50±0.05	18.0±0.6	0.8 - 2.2
SFV25S270K	12.0±3.0	28	4.00±0.05	2.00±0.05	30	2.00±0.05	4.5	0.50±0.05	2.50±0.05	18.0±0.6	0.9 - 2.4
SFV25S330K	12.0±3.0	28	4.00±0.05	2.00±0.05	30	2.00±0.05	4.8	0.50±0.05	2.50±0.05	18.0±0.6	1.0 - 2.6
SFV25S390K	12.0±3.0	28	4.00±0.05	2.00±0.05	30	2.00±0.05	5.1	0.50±0.05	2.50±0.05	18.0±0.6	1.1 - 2.8
SFV25S470K	12.0±3.0	28	4.00±0.05	2.00±0.05	30	2.00±0.05	4.3	0.50±0.05	2.50±0.05	18.0±0.6	0.9 - 2.4
SFV25S560K	12.0±3.0	28	4.00±0.05	2.00±0.05	30	2.00±0.05	4.5	0.50±0.05	2.50±0.05	18.0±0.6	1.0 - 2.6
SFV25S680K	12.0±3.0	28	4.00±0.05	2.00±0.05	30	2.00±0.05	4.8	0.50±0.05	2.50±0.05	18.0±0.6	1.2 - 2.9
SFV25S820K	12.0±3.0	28	4.00±0.05	2.00±0.05	30	2.00±0.05	4.1	0.50±0.05	2.50±0.05	18.0±0.6	0.9 - 2.3
SFV25S101K	12.0±3.0	28	4.00±0.05	2.00±0.05	30	2.00±0.05	4.3	0.50±0.05	2.50±0.05	18.0±0.6	1.0 - 2.5
SFV25S121K	12.0±3.0	28	4.00±0.05	2.00±0.05	30	2.00±0.05	4.5	0.50±0.05	2.50±0.05	18.0±0.6	1.1 - 2.7
SFV25S151K	12.0±3.0	28	4.00±0.05	2.00±0.05	30	2.00±0.05	4.8	0.50±0.05	2.50±0.05	18.0±0.6	1.4 - 3.0
SFV25S181K	12.0±3.0	28	4.00±0.05	2.00±0.05	30	2.00±0.05	4.3	0.50±0.05	2.50±0.05	18.0±0.6	1.1 - 2.6
SFV25S201K	12.0±3.0	28	4.00±0.05	2.00±0.05	30	2.00±0.05	4.4	0.50±0.05	2.50±0.05	18.0±0.6	1.2 - 2.7
SFV25S221K	12.0±3.0	28	4.00±0.05	2.00±0.05	30	2.00±0.05	4.5	0.50±0.05	2.50±0.05	18.0±0.6	1.3 - 2.8
SFV25S241K	12.0±3.0	28	4.00±0.05	2.00±0.05	30	2.00±0.05	4.6	0.50±0.05	2.50±0.05	18.0±0.6	1.4 - 2.9
SFV25S271K	12.0±3.0	28	4.00±0.05	2.00±0.05	30	2.00±0.05	4.8	0.50±0.05	2.50±0.05	18.0±0.6	1.5 - 3.1
SFV25S301K	12.0±3.0	28	4.00±0.05	2.00±0.05	30	2.00±0.05	5.0	0.50±0.05	2.50±0.05	18.0±0.6	1.6 - 3.3
SFV25S331K	12.0±3.0	28	4.00±0.05	2.00±0.05	30	2.00±0.05	5.2	0.50±0.05	2.50±0.05	18.0±0.6	1.7 - 3.4
SFV25S361K	12.0±3.0	28	4.00±0.05	2.00±0.05	30	2.00±0.05	5.4	0.50±0.05	2.50±0.05	18.0±0.6	1.8 - 3.6
SFV25S391K	12.0±3.0	28	4.00±0.05	2.00±0.05	30	2.00±0.05	5.6	0.50±0.05	2.50±0.05	18.0±0.6	1.9 - 3.8
SFV25S431K	12.0±3.0	28	4.00±0.05	2.00±0.05	30	2.00±0.05	5.8	0.50±0.05	2.50±0.05	18.0±0.6	2.0 - 4.0
SFV25S471K	12.0±3.0	28	4.00±0.05	2.00±0.05	30	2.00±0.05	6.1	0.50±0.05	2.50±0.05	18.0±0.6	2.3 - 4.3
SFV25S511K	12.0±3.0	28	4.00±0.05	2.00±0.05	30	2.00±0.05	6.3	0.50±0.05	2.50±0.05	18.0±0.6	2.5 - 4.5
SFV25S561K	12.0±3.0	28	4.00±0.05	2.00±0.05	30	2.00±0.05	6.6	0.50±0.05	2.50±0.05	18.0±0.6	2.8 - 4.8
SFV25S621K	12.0±3.0	28	4.00±0.05	2.00±0.05	30	2.00±0.05	7.0	0.50±0.05	2.50±0.05	18.0±0.6	3.1 - 5.1
SFV25S681K	12.0±3.0	28	4.00±0.05	2.00±0.05	30	2.00±0.05	7.4	0.50±0.05	2.50±0.05	18.0±0.6	3.5 - 5.5
SFV25S751K	12.0±3.0	28	4.00±0.05	2.00±0.05	30	2.00±0.05	7.8	0.50±0.05	2.50±0.05	18.0±0.6	3.9 - 5.9
SFV25S821K	12.0±3.0	28	4.00±0.05	2.00±0.05	30	2.00±0.05	8.3	0.50±0.05	2.50±0.05	18.0±0.6	4.3 - 6.3
SFV25S911K	12.0±3.0	28	4.00±0.05	2.00±0.05	30	2.00±0.05	8.8	0.50±0.05	2.50±0.05	18.0±0.6	4.9 - 6.9
SFV25S102K	12.0±3.0	28	4.00±0.05	2.00±0.05	30	2.00±0.05	9.4	0.50±0.05	2.50±0.05	18.0±0.6	5.4 - 7.4
SFV25S112K	12.0±3.0	28	4.00±0.05	2.00±0.05	30	2.00±0.05	10.0	0.50±0.05	2.50±0.05	18.0±0.6	6.0 - 8.0
SFV25S122K	12.0±3.0	28	4.00±0.05	2.00±0.05	30	2.00±0.05	10.6	0.50±0.05	2.50±0.05	18.0±0.6	6.6 - 8.6

MOV

MOV

Dimensions (mm)

Model	L	W (Max.)	H (Max.)	T (Max.)	d	F	F ₁
SFV25S220K	16.0±3.0	28	30	6.6	1.20±0.05	18.0±0.6	2.0 - 3.9
SFV25S270K	16.0±3.0	28	30	6.9	1.20±0.05	18.0±0.6	2.1 - 4.1
SFV25S330K	16.0±3.0	28	30	7.2	1.20±0.05	18.0±0.6	2.3 - 4.3
SFV25S390K	16.0±3.0	28	30	7.5	1.20±0.05	18.0±0.6	2.5 - 4.5
SFV25S470K	16.0±3.0	28	30	6.7	1.20±0.05	18.0±0.6	2.1 - 4.1
SFV25S560K	16.0±3.0	28	30	6.9	1.20±0.05	18.0±0.6	2.3 - 4.3
SFV25S680K	16.0±3.0	28	30	7.2	1.20±0.05	18.0±0.6	2.6 - 4.6
SFV25S820K	16.0±3.0	28	30	6.5	1.20±0.05	18.0±0.6	2.0 - 4.0
SFV25S101K	16.0±3.0	28	30	6.7	1.20±0.05	18.0±0.6	2.2 - 4.2
SFV25S121K	16.0±3.0	28	30	6.9	1.20±0.05	18.0±0.6	2.4 - 4.4
SFV25S151K	16.0±3.0	28	30	7.2	1.20±0.05	18.0±0.6	2.7 - 4.7
SFV25S181K	16.0±3.0	28	30	6.7	1.20±0.05	18.0±0.6	2.3 - 4.3
SFV25S201K	16.0±3.0	28	30	6.8	1.20±0.05	18.0±0.6	2.4 - 4.4
SFV25S221K	16.0±3.0	28	30	6.9	1.20±0.05	18.0±0.6	2.5 - 4.5
SFV25S241K	16.0±3.0	28	30	7.0	1.20±0.05	18.0±0.6	2.6 - 4.6
SFV25S271K	16.0±3.0	28	30	7.2	1.20±0.05	18.0±0.6	2.8 - 4.8
SFV25S301K	16.0±3.0	28	30	7.4	1.20±0.05	18.0±0.6	3.0 - 5.0
SFV25S331K	16.0±3.0	28	30	7.6	1.20±0.05	18.0±0.6	3.1 - 5.1
SFV25S361K	16.0±3.0	28	30	7.8	1.20±0.05	18.0±0.6	3.3 - 5.3
SFV25S391K	16.0±3.0	28	30	8.0	1.20±0.05	18.0±0.6	3.5 - 5.5
SFV25S431K	16.0±3.0	28	30	8.2	1.20±0.05	18.0±0.6	3.7 - 5.7
SFV25S471K	16.0±3.0	28	30	8.5	1.20±0.05	18.0±0.6	4.0 - 6.0
SFV25S511K	16.0±3.0	28	30	8.7	1.20±0.05	18.0±0.6	4.2 - 6.2
SFV25S561K	16.0±3.0	28	30	9.0	1.20±0.05	18.0±0.6	4.5 - 6.5
SFV25S621K	16.0±3.0	28	30	9.4	1.20±0.05	18.0±0.6	4.8 - 6.8
SFV25S681K	16.0±3.0	28	30	9.8	1.20±0.05	18.0±0.6	5.2 - 7.2
SFV25S751K	16.0±3.0	28	30	10.2	1.20±0.05	18.0±0.6	5.6 - 7.6
SFV25S821K	16.0±3.0	28	30	10.7	1.20±0.05	18.0±0.6	6.0 - 8.0
SFV25S911K	16.0±3.0	28	30	11.2	1.20±0.05	18.0±0.6	6.6 - 8.6
SFV25S102K	16.0±3.0	28	30	11.8	1.20±0.05	18.0±0.6	7.1 - 9.1
SFV25S112K	16.0±3.0	28	30	12.4	1.20±0.05	18.0±0.6	7.7 - 9.7
SFV25S122K	16.0±3.0	28	30	13.0	1.20±0.05	18.0±0.6	8.3 - 10.3

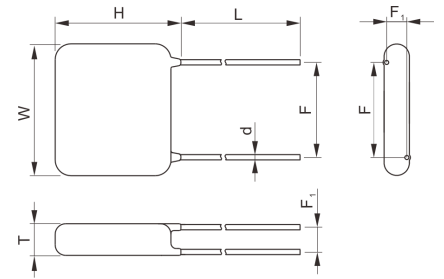

Straight Lead

Note:

The above data is for reference only.

Specification

Model	Max. Continuous Operating Voltage		Varistor Voltage @1 mA DC		Clamping Voltage (Max.)		Max. Discharge Current (8/20 μs)		Max. Energy (10/1000 μs)	Typical Capacitance (For reference only) @1 kHz	Agency Approvals			
	Vac	Vdc	Min.	Max.	V _C	I _P	I _n	I _{max}			UL	cUL	TUV	CQC
	(V)	(V)	(V)	(V)	(V)	(A)	(kA)	(kA)	(J)	(pF)				
SFV25S220K	14	18	20	24	43	35	1.5	3	20	35000	●	●	○	○
SFV25S270K	17	22	24	31	53	35	3	6	33	30000	●	●	●	○
SFV25S330K	20	26	30	36	65	35	4	8	42	24500	●	●	●	○
SFV25S390K	25	31	35	43	77	35	4	8	49	21000	●	●	●	○
SFV25S470K	30	38	42	52	93	35	4	8	60	17250	●	●	●	○
SFV25S560K	35	45	50	62	110	35	5	10	72	14500	●	●	●	○
SFV25S680K	40	56	61	75	135	35	5	10	85	9500	●	●	●	○
SFV25S820K	50	65	74	90	135	175	10	25	98	8800	●	●	●	○
SFV25S101K	60	85	90	110	165	175	10	25	122	7200	●	●	●	○
SFV25S121K	75	100	108	132	200	175	10	25	146	6000	●	●	●	○
SFV25S151K	95	125	135	165	250	175	10	25	185	4400	●	●	●	○
SFV25S181K	115	150	162	198	300	175	10	25	218	3650	●	●	●	○
SFV25S201K	130	170	180	220	340	175	10	25	252	3300	●	●	●	○
SFV25S221K	140	180	198	242	360	175	10	25	280	3000	●	●	●	○
SFV25S241K	150	200	216	264	395	175	10	25	302	2800	●	●	●	○
SFV25S271K	175	225	243	297	455	175	10	25	340	2450	●	●	●	○
SFV25S301K	190	250	270	330	500	175	10	25	375	2200	●	●	●	○
SFV25S331K	210	275	297	363	550	175	10	25	410	2050	●	●	●	○
SFV25S361K	230	300	324	396	595	175	10	25	465	1850	●	●	●	○
SFV25S391K	250	320	351	429	650	175	10	25	520	1700	●	●	●	○
SFV25S431K	275	350	387	473	710	175	10	25	575	1600	●	●	●	○
SFV25S471K	300	385	423	517	775	175	10	25	630	1450	●	●	●	○
SFV25S511K	320	415	459	561	845	175	10	25	665	1300	●	●	●	○
SFV25S561K	350	460	504	616	925	175	10	25	720	1200	●	●	●	○
SFV25S621K	385	505	558	682	1025	175	10	25	790	1100	●	●	●	○
SFV25S681K	420	560	612	748	1120	175	10	25	790	1000	●	●	●	○
SFV25S751K	460	615	675	825	1240	175	10	25	825	900	●	●	●	○
SFV25S821K	510	670	738	902	1355	175	10	25	840	800	●	●	●	○
SFV25S911K	550	745	819	1001	1500	175	10	25	900	700	●	●	●	○
SFV25S102K	625	825	900	1100	1650	175	10	25	950	660	●	●	●	○
SFV25S112K	680	895	990	1210	1815	175	10	25	1040	615	●	●	●	○
SFV25S122K	750	1000	1080	1320	1980	175	10	25	1170	555	●	●	●	○

● : Approved ○ : Unauthorized

MOV

MOV

Performance Curve (For reference only)

- Max. Peak Current Derating Curves

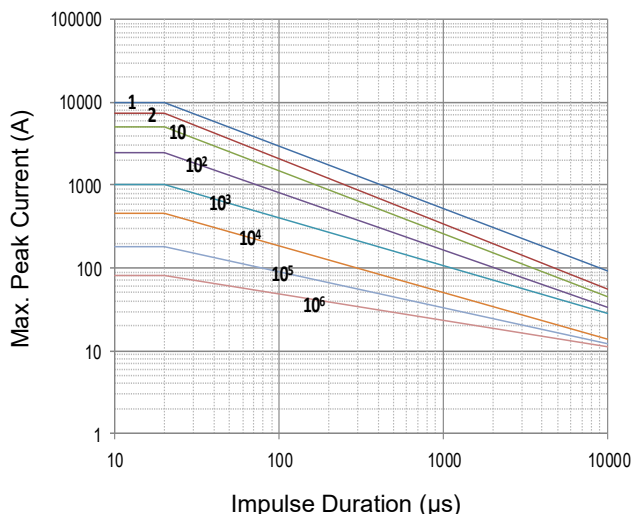

SFV25S220K to SFV25S680K

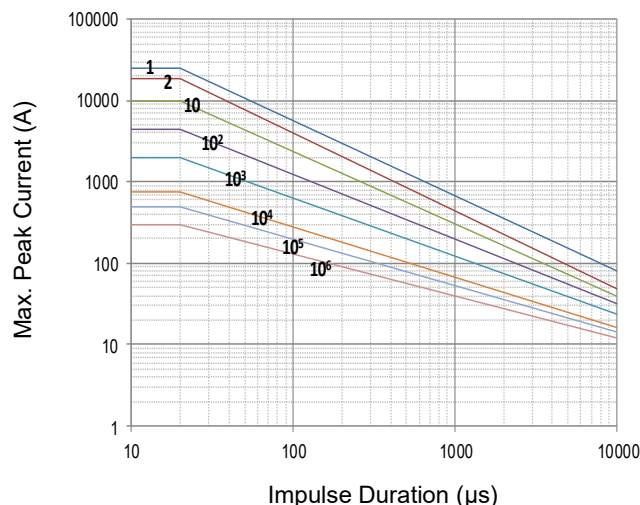

SFV25S820K to SFV25S122K

Note: 1, 2, 10, 10², 10³, 10⁴, 10⁵, 10⁶ Stand for Repetitions.

- Voltage-Current Characteristic Curves

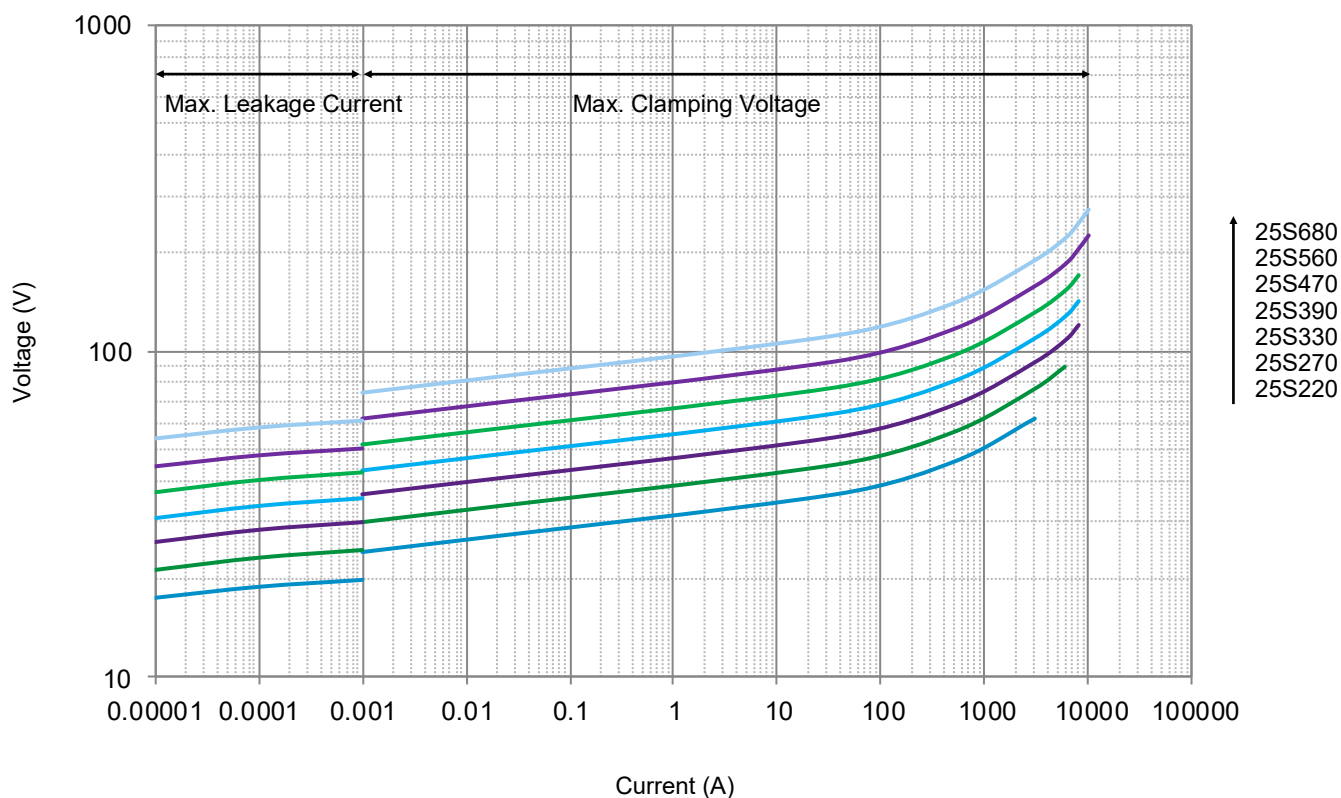

• Voltage-Current Characteristic Curves

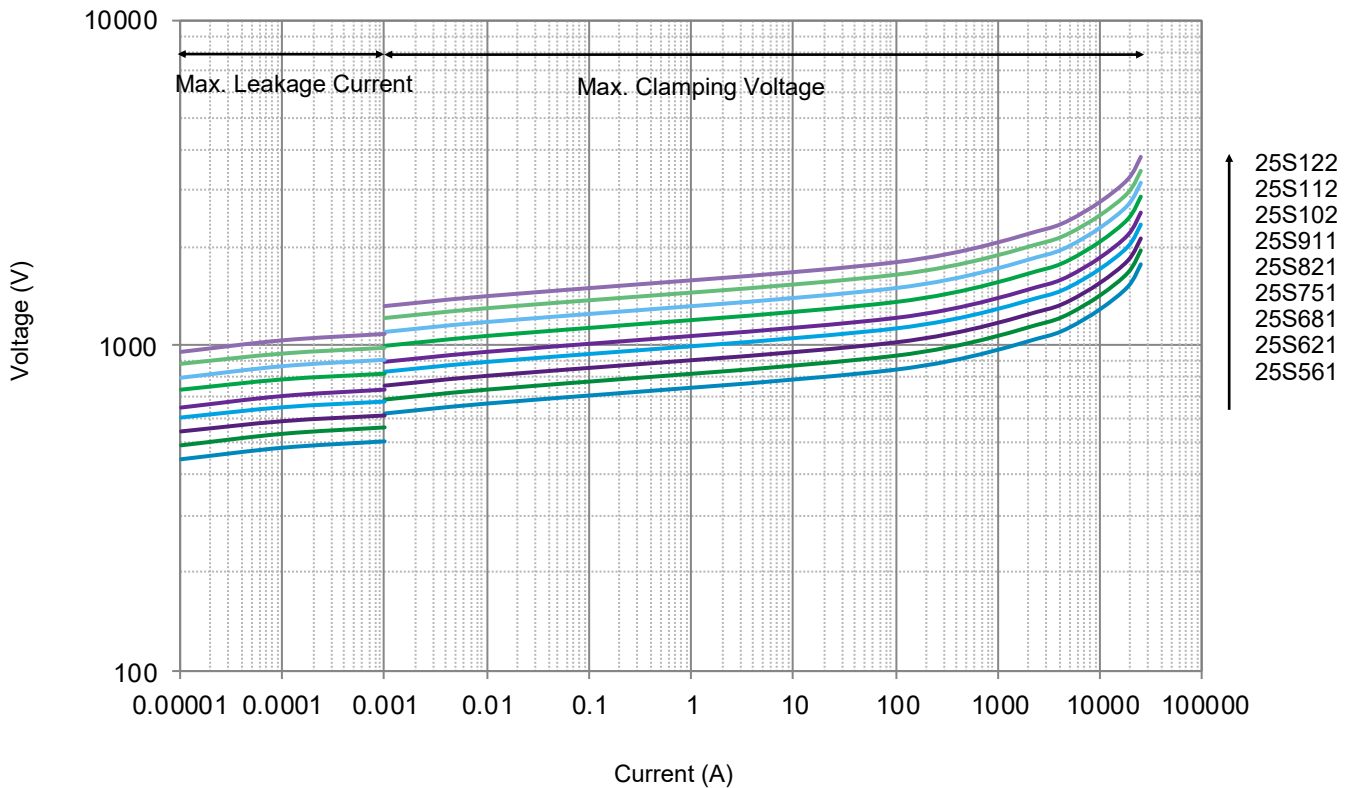
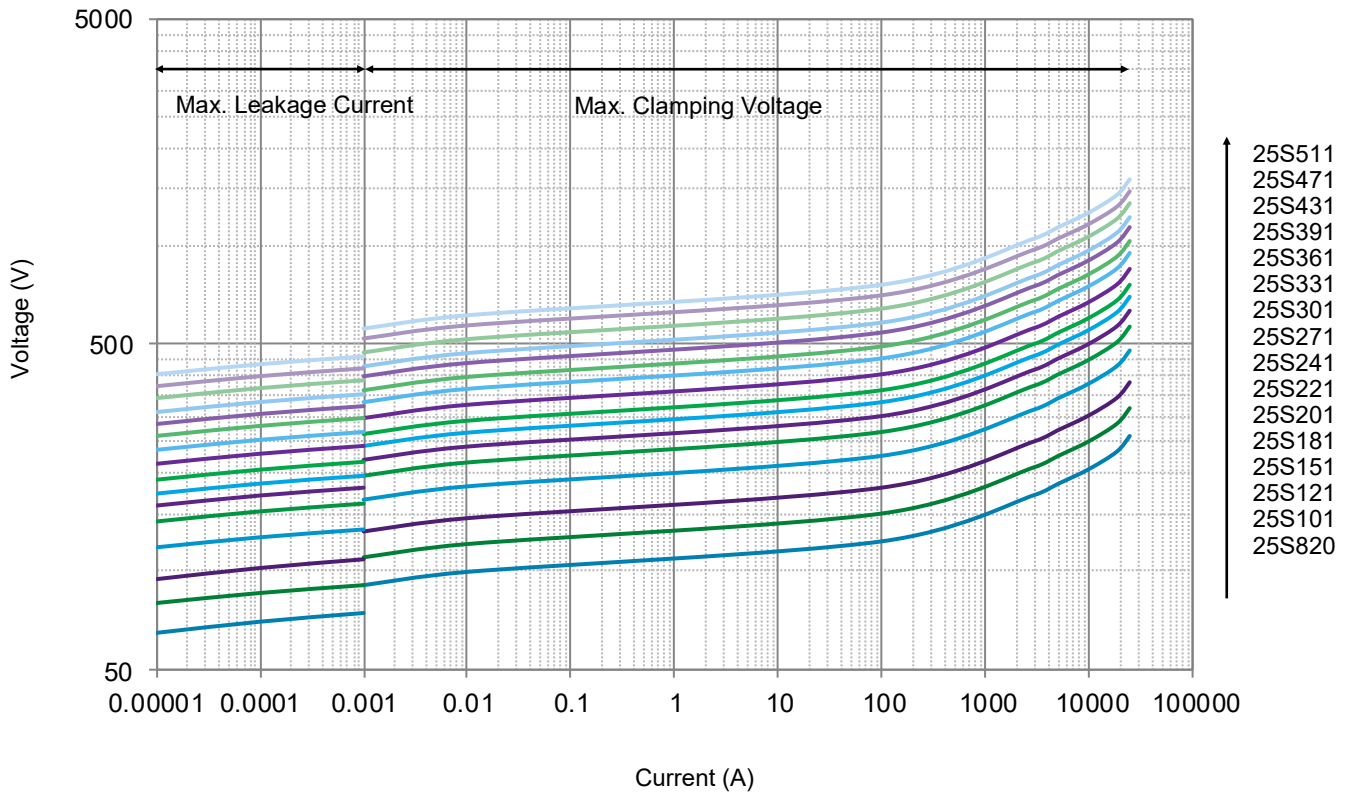

MOV

MOV

Soldering Parameters

Wave Soldering Parameters

The wave soldering parameters are for reference only. When MOV is for practice use, some related validation is recommended.

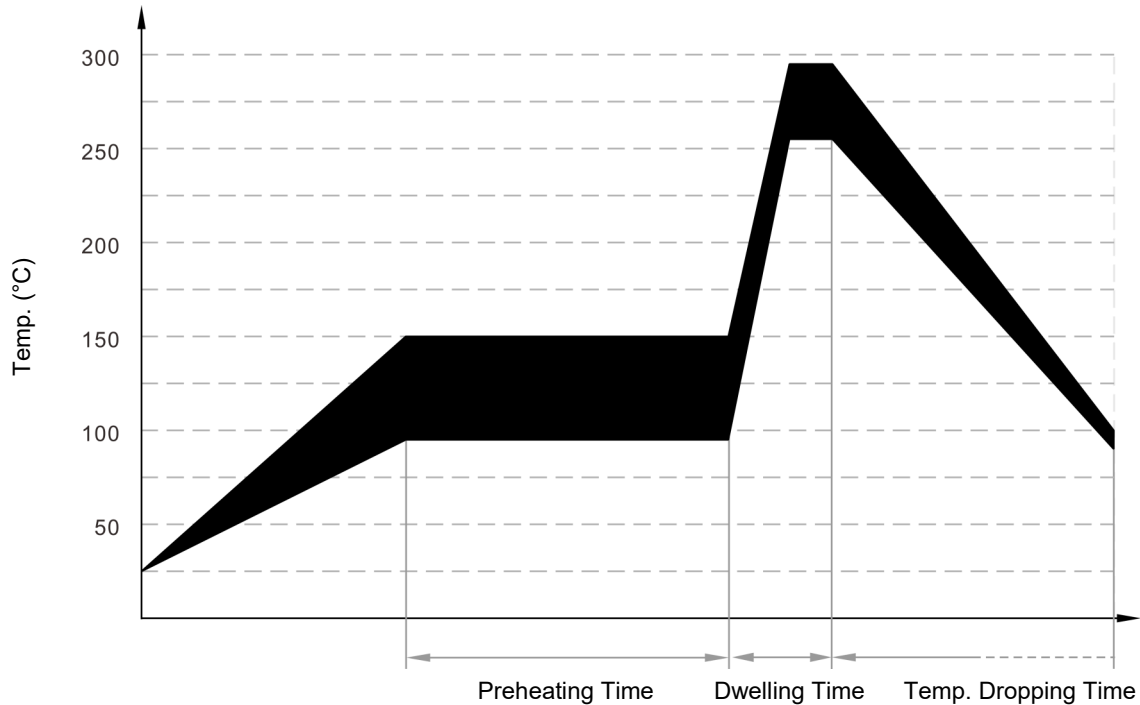

Wave Soldering Curve

Item	Temp. (°C)	Time (s)
Preheating	90 to 150	<150
Dwelling	255 to 290	3 to 10

Recommended Hand-Soldering Parameters

Item	Condition
Temp. of Solder Head	350 °C (max.)
Soldering Time	4 seconds (max.)

Packaging Information

- Bulk Packaging (Code: BUL)
- Bulk Packaging Quantity & Weight.

Series	Nominal Varistor Voltage	PE Bag	Box	Carton	G. W / Carton (365 × 265 × 245)
	(V)	(PCS)	(PCS)	(PCS)	(kg)±10%
25S	220 - 821	100	200	1200	10 - 26
	911 - 122	80	160	960	23 - 28

Note:
Other lead length packaging information, please contact SETsafe | SETfuse.

All Dimensions in mm

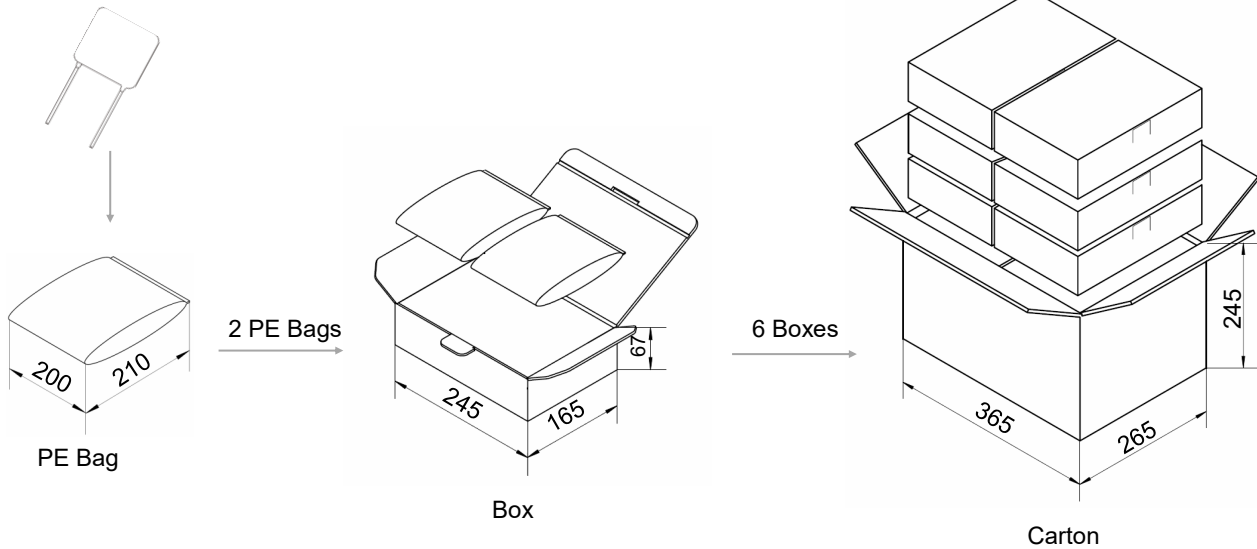

MOV

MOV



ATTENTION

MOV

MOV

Usage

1. Varistor must operated in the specified ambient temp.
2. Do not clean the varistor with strong polar solvent such as ketone, esters, benzene and halogenated hydrocarbon.
3. Please do not apply severe vibration, shock or pressure to MOV.
4. Please fix lead wires when bending or cutting. The distance between the bending point and the sealing of MOV shall be greater than 2 mm.

Replacement

If varistor is visually damaged, please replace it.

Storage

1. Storage Temp. Range: (-40 to +125) °C
2. Relative Humidity : ≤75% RH
3. Altitude: <2000 m
4. Do not store the MOV at the high temp., high humidity or corrosive gas environment, to avoid influencing the solder-ability of the lead wires, the product shall be used up within 1 year after receiving the goods.

Environmental Conditions

1. Varistor should neither be exposed to the open air, nor direct sunshine.
2. Varistor should avoid rain, water vapor or other condition of high temp. and high humidity.
3. Varistor should avoid sand dust, salt spray, or other harmful gases.

Max. Typical Capacitance of Varistor

The typical capacitance of varistor is listed in the specifications. Designers may refer to it when designing MOV in high frequency circuit.

Installation

Mechanical Stress

Do not knock MOV when installing, to avoid mechanical damage.